

LES CIRCUITS

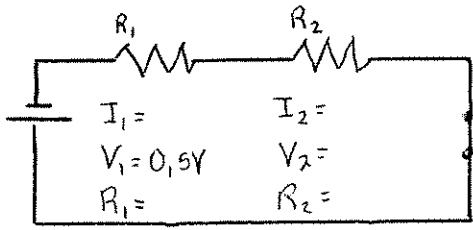

$V_T = 1,5V$
 $I_T = 0,25A$

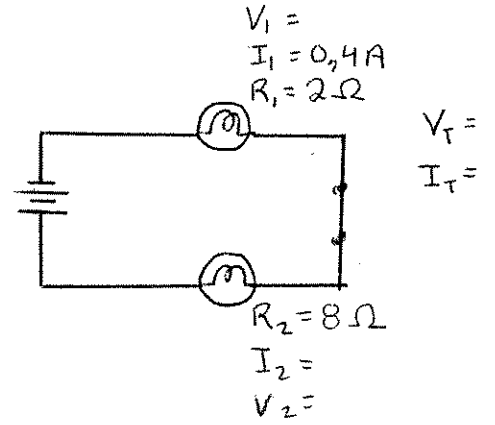

$V_T =$
 $I_T =$

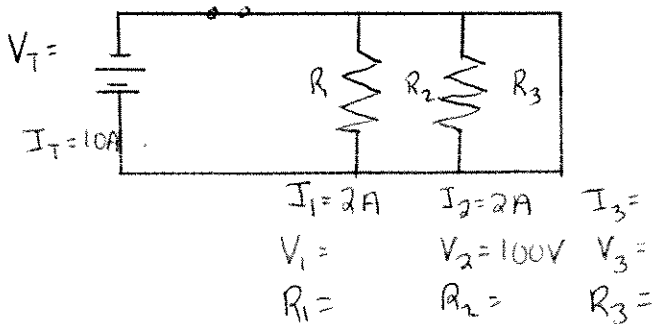
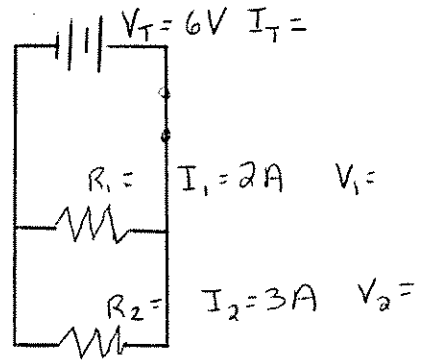
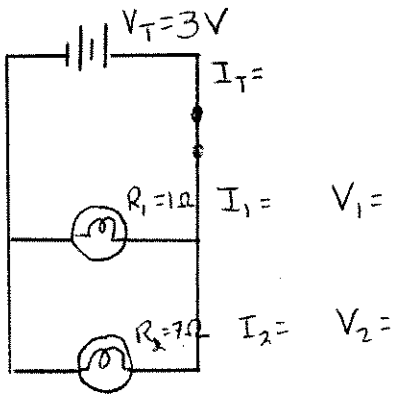
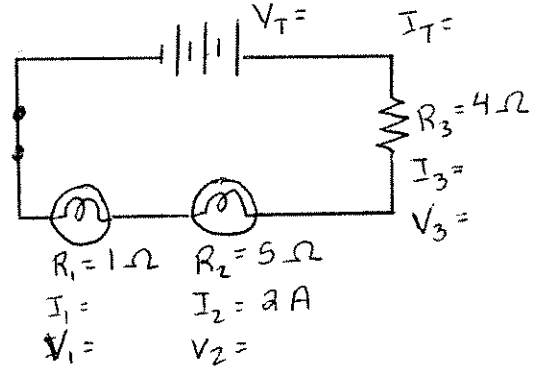
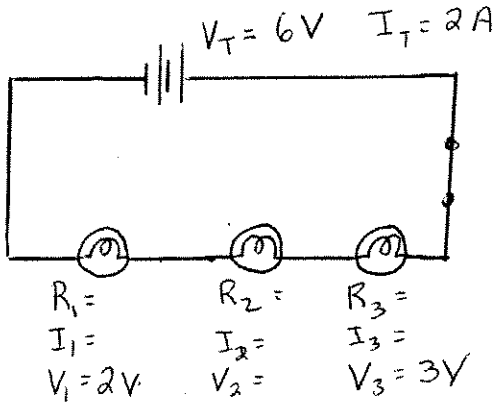

LES CIRCUITS clé

